

IMPORTANT: RECEIVING INSTRUCTIONS

Visually inspect all components for shipping damage. If you find damage, notify the carrier at once. Shipping damage is NOT covered by warranty. The carrier is responsible for all repair or replacement costs resulting from damage in shipment.

Read this owners manual thoroughly before use and save.

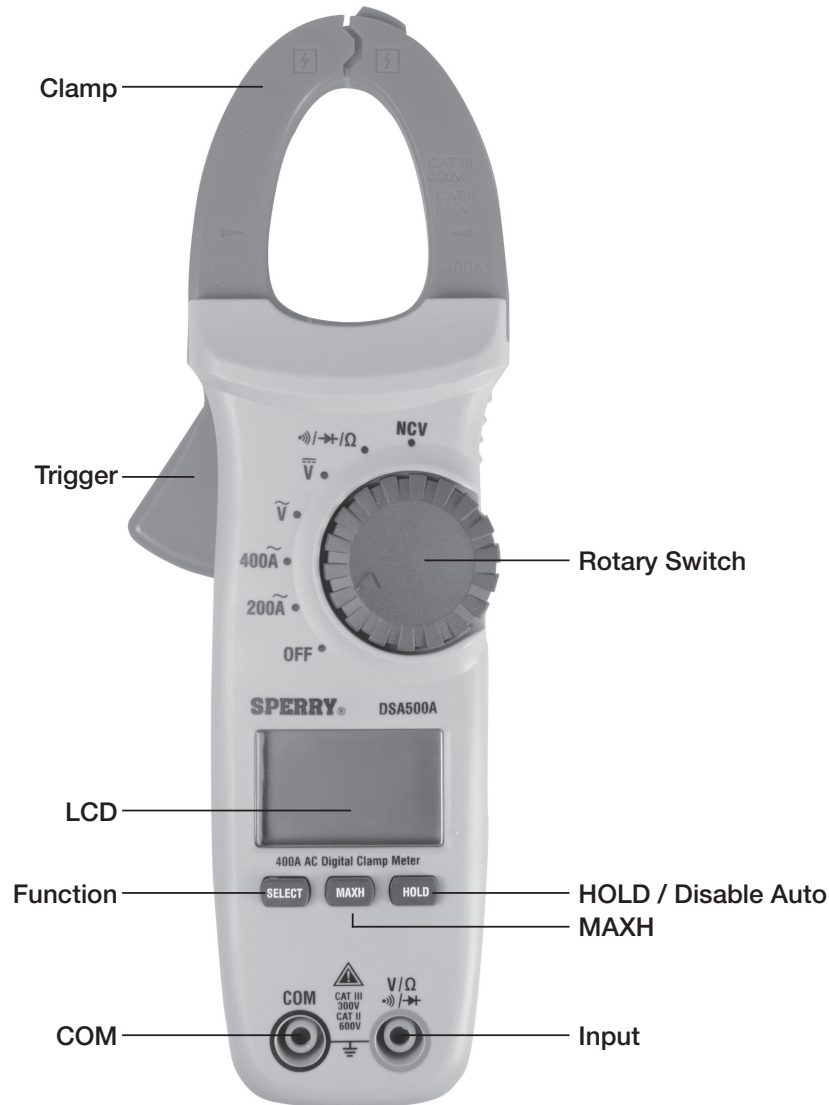

Figure 1





Rotary Switch

NCV	Non-Contact Voltage Measurement
$\bullet \text{ } \text{ } / \rightarrow \text{+} / \Omega$	Continuity Test/Diode Test/ Resistance Measurement
\bar{V}	DC Voltage Measurement
\tilde{V}	AC Voltage Measurement
400 \tilde{A}	AC Current Measurement
200 \tilde{A}	AC Current Measurement
OFF	Power Off

Function Selection

BUTTON	OPERATION PERFORMED
SELECT	Switch between Continuity, Diode, and Resistance at the $\bullet \text{ } \text{ } / \rightarrow \text{+} / \Omega$ measurement settings
MAXH	Retain the highest measurement value being recorded
HOLD	Retain the measured value on the LCD screen

Display Symbols

AC	Alternating Current	MAX	Maximum Value	NCV	Non-contact Voltage Detection	Ω , k Ω , M Ω	Ohm, Kiloohm, Megaohm (Resistance)
—	Negative Value		Data Hold		Low Battery	OL	Overload
DC	Direct Current		Diode Check	μ A, mA, A	Amperes, Milliamp, Microamp (Current)		
AUTO	Auto Ranging		Continuity	mV, V	Millivolt, Volt		



1. FEATURES AND MEASUREMENT FUNCTIONS

- 1999 count display
- Contoured body provides comfortable single handed grip
- Auto ranging
- Auto shut off features to extend battery life
- Auto shut off disable feature
- Low battery indicator
- Data hold
- Polarity indication: Automatic, + Implied, Negative Polarity Indicator
- Over range indication: 'OL'
- Overload protection
- Non-contact voltage detection: 50 to 500 VAC
- Resistance measurement: 0.1 Ω - 20M Ω
- Continuity check: Provides an audible indication below 30 Ω
- Diode check: Measure the forward voltage drop across a diode junction
- DC voltage measurement: 600 VDC max
- AC voltage measurement: 600 VAC max
- AC current measurement: 400A max

2. SAFETY WARNINGS

- This instruction manual contains warnings and safety rules which must be observed by the user to ensure safe operation of the instrument and retain it in safe condition.
- Read through and understand the instructions contained in this manual before using the instrument.
- Keep the manual at hand to enable quick reference whenever necessary.
- The instrument is to be used only in its intended applications.
- Understand and follow all the safety instructions contained in the manual.
- It is essential that all safety instructions are adhered to.
- Failure to follow the safety instructions may cause injury, instrument damage.

The symbol  indicated on the instrument means that the user must refer to the related parts in the manual for safe operation of the instrument. It is essential to read the instructions wherever the symbol appears in the manual.

 DANGER is reserved for conditions and actions that are likely to cause serious or fatal injury.
 WARNING is reserved for conditions and actions that can cause serious or fatal injury.
 CAUTION is reserved for conditions and actions that can cause injury or instrument damage.

DANGER

- Never make measurement on a circuit in which voltage over 600V exists.
- Do not exceed the CAT rating of the measuring device
- Do not attempt to make measurement in the presence of flammable gases.
The use of the instrument may cause sparking, which can lead to an explosion.
- Transformer jaw tips are designed to not short the circuit during a test. If equipment under test has exposed conductive parts extra precaution should be taken to minimize the possibility of shorting.
- Never use the instrument if its surface or your hand is wet.
- Do not exceed the maximum allowable input of any measuring range.
- Never open the battery cover during a measurement.
- The instrument is to be used only in its intended applications or conditions.
Use in other than as intended may cause instrument damage or serious personal injury.

WARNING

- Never attempt to make any measurement if any abnormal conditions are noted, such as broken case, cracked test leads and exposed metal part.
- Do not turn the function selector switch with plugged in test leads connected to the circuit under test.
- Do not install substitute parts or make any modification to the instrument.
Return the instrument to your distributor for repair or recalibration.
- Do not try to replace the batteries if the surface of the instrument is wet.
- Always switch off the instrument before opening the battery compartment cover for battery replacement.







CAUTION

- Set the Function Switch to an appropriate position before starting measurement.
- Firmly insert the test leads.
- Disconnect the test leads from the instrument for current measurement.
- Do not expose the instrument to the direct sun, high temperature and humidity or dewfall.
- Be sure to power off the instrument after use. When the instrument will not be in use for a long period, place it in storage after removing the batteries.
- Use only a soft cloth dampened with water or neutral detergent for cleaning the meter.
Do not use abrasives, solvents or harsh chemicals. Allow to dry thoroughly before use.

Measurement categories (Over-voltage categories)

To ensure safe operation of measuring instruments, IEC61010 establishes safety standards for various electrical environments, specified as CAT I through CAT IV, and called measurement categories. Higher-numbered categories correspond to electrical environments with greater momentary energy, so a measuring instrument designed for CAT III environments can endure greater momentary energy than one designed for CAT II.

- **CAT I:** Secondary electrical circuits connected to an AC electrical outlet through a transformer or similar device.
- **CAT II:** Primary electrical circuits of equipment connected to an AC electrical outlet by a power cord.
- **CAT III:** Primary electrical circuits of the equipment connected directly to the distribution panel, and feeders from the distribution panel to outlets.
- **CAT IV:** The circuit from the service drop to the service entrance, and to the power meter and primary over current protection device (distribution panel).

Symbols	
	Important Information; Refer to manual
	Conformité Européenne ("European Conformity")
	Designates the product as recyclable electronic waste per WEEE Directive
	Double Insulated
	AC (Alternating Current)
	AC/DC Selectable (Alternating Current/Direct Current)
	Earth Ground

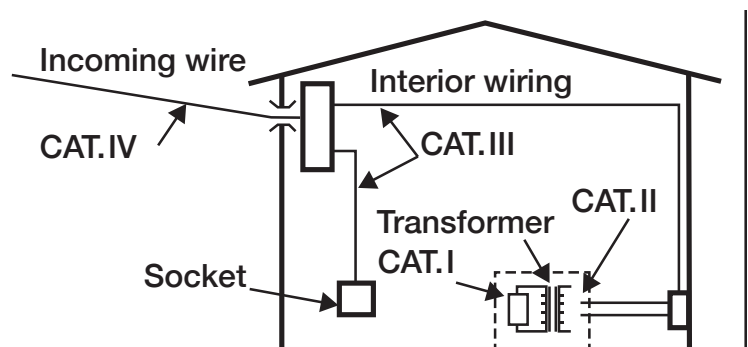

3. SPECIFICATION

3-1. Measuring range & accuracy

(Accuracy guaranteed at 23°C ± 5°C, humidity <80%)

AC CURRENT

RANGE	RESOLUTION	ACCURACY
200A	0.1A	± (2.0% + 5)
400A	1A	

- Main Display: Average Current
- Frequency Response: 50Hz ~ 60Hz

AC VOLTAGE

RANGE	RESOLUTION	ACCURACY
2V	0.001V	±(2.0%+5)
20V	0.01V	
200V	0.1V	
600V	1V	

- Main Display: Average Voltage.
- Input Impedance: ≥10MΩ
- Frequency Response: 40Hz ~ 400Hz

DC VOLTAGE

RANGE	RESOLUTION	ACCURACY
200mV	0.1mV	±(1.5%+5)
2V	0.001V	
20V	0.01V	
200V	0.1V	
600V	1V	

- Input Impedance: ≥10MΩ

RESISTANCE

RANGE	RESOLUTION	ACCURACY
200Ω	0.1Ω	±(2.0%+5)
2KΩ	0.001kΩ	
20KΩ	0.01kΩ	
200KΩ	0.1kΩ	
2MΩ	0.001MΩ	
20MΩ	0.01MΩ	

- Open-circuit voltage: about 0.45V

CONTINUITY TEST

RANGE	RESOLUTION	ACCURACY
	0.1Ω	≤30Ω buzzer beep ≥100Ω No buzzer beep, "OL"

- Open-circuit voltage: about 0.45V

DIODE TEST

RANGE	RESOLUTION	ACCURACY
	0.001V	Forward Voltage Drop: 0.5V ~ 0.8V

- Open-circuit voltage: about 1.48V

NCV

RANGE	DETECTION DISTANCE	APPLICATION
50V/50HZ	0 ~ 1"	Insulated Wire
120V/50HZ	0 ~ 2"	Outlet box w/ cover
500V/50HZ	0 ~ 12"	Outlet box w/o cover

3-2. General Specification

- The maximum voltage allowed between terminal and ground: 600 VDC or 600 VAC
- Altitude: Maximum 2000m
- Display: 1999 count
- Sampling time: ~ 3 times / sec
- Automatic power off: 15 Minutes (Unless disabled)
- Battery type: (3) 1.5V AAA
- Temperature coefficient: $<.1 \times (\text{specified accuracy}) / ^\circ\text{C}$
- Operating temperature: $0^\circ\text{C} \sim 50^\circ\text{C}$
- Storage temperature: $-20^\circ\text{C} \sim 60^\circ\text{C}$
- Approximate size: 8.6" x 2.57" x 1.61"
- Weight: ~273.3 grams (Including batteries, excluding leads)
- Impact resistance: 3m
- Crush test: 250 lbs
- Drop test: 10 ft
- Max open size of jaw diameter: 28mm
- Safety: IEC61010-1; IEC61010-2-032; CATII 600Vm, CATIII 300V

3-3. Accessories

- 1 red & 1 black 1000V, 20A test lead
- 3 AAA batteries
- Carrying case

4. PREPARATION FOR MEASUREMENT

4-1. Check the condition of the meter

Do not use a meter with visible signs of damage. Examine the meter housing before you use the product. Look for cracks, missing plastic or exposed metal. Carefully examine the insulation around the Common and Input terminals.

4-2. Check the battery voltage

Start with the dial in the "OFF" position then rotate the dial to any position. Confirm that the low battery symbol is not displayed on the LCD screen. If the low battery symbol  is displayed follow the instructions in Section 7, Battery Replacement. (It is important to start from the "OFF" position to ensure that a blank screen is not due to the auto off feature.)

4-3. Check the battery cover

The battery cover must be in place and securely fastened before powering on the meter or connecting test leads to a circuit. See Section 7, Battery Replacement

4-4. Check test lead condition, continuity and rating

Do not use damaged test leads. Examine the test leads for worn or cracked insulation. Check test lead continuity. Do not use test leads in applications that exceed their CAT rating. Check the CAT rating of the test lead and refer to Figure 3.

4-5. Checking the switch setting & operation

Confirm the dial is set to the correct position for the measurement function being performed. Confirm that the symbols displayed on the LED screen match the measurement function. (Refer to Figure 2). Ensure that the Data Hold feature is disabled.

5. MEASUREMENT

5-1. Resistance/Continuity/Diode

RESISTANCE MEASUREMENT Ω

1. Insert test leads - Insert the black test lead into the **COM** input and the red test lead into the $\frac{V}{\Omega}$ input.

2. Set Ω function - Turn the dial to the $\bullet \rightarrow \rightarrow \rightarrow / \rightarrow \rightarrow / \Omega$ function.

3. Select Function - There are a total of 3 functions that are accessible by pressing the **SELECT** key.

The Resistance function is the default option. Press the **SELECT** key until Ω appears on the display.

4. Short the tips of the test leads - Short the tips of the test leads together and confirm the LCD screen shows near zero.

5. Test & Measure - Place the red and black test leads at both the positive and negative points to be measured. The clamp meter will automatically select the proper range and the display will show the resistance value of the measurement being taken on the display. When the test leads are not connected or the resistance value is too great, the display will show an over-range symbol "OL".

WARNING

When measuring resistance, the circuit should be powered off and all capacitors should be completely discharged prior to testing. A more accurate measurement can be achieved by separating the component from the circuit being tested.

CONTINUITY TEST $\bullet\Omega$

1. **Insert test leads** - Insert the black test lead into the **COM** input and the red test lead into the $\frac{V}{\Omega}$ input.

2. **Set $\bullet\Omega$ function** - Turn the dial to the $\bullet\Omega$ / $\rightarrow\Omega$ / Ω function.

3. **Select Function** - There are a total of 3 functions that are accessible by pressing the **SELECT** key. Press the **SELECT** key until $\bullet\Omega$ appears on the display.

4. **Short the tips of the test leads** – Short the tips of the test leads together and confirm the LCD screen shows near zero. The meter should emit a tone.

5. **Test & Measure** - Place the red and black test leads at both the positive and negative points to be measured. The buzzer will sound when the resistance is less than 30Ω . When the test leads are not connected or the resistance value is to greater than 100Ω , the display will show an over-range symbol “OL” and the buzzer will remain silent.

\triangle WARNING

When measuring continuity, all power to the circuit or cable being tested MUST be turned off to prevent damage to the user or the clamp meter.

DIODE MEASUREMENT $\rightarrow\Omega$

1. **Insert test leads** - Insert the black test lead into the **COM** input and the red test lead into the $\frac{V}{\Omega}$ input.

2. **Set $\rightarrow\Omega$ function** - Turn the dial to the $\bullet\Omega$ / $\rightarrow\Omega$ / Ω function.

3. **Selection Function** - There are a total of 3 functions that are accessible by pressing the **SELECT** key. Press the **SELECT** key until $\rightarrow\Omega$ appears on the display.

4. **Test & Measure** - For forward voltage drop readings on any semiconductor component, place the red test lead on the components anode and place the black test lead on the components cathode. When the test leads are not connected or are reversed, the display will show an over-range symbol “OL”.

\triangle WARNING

When measuring resistance, the circuit should be powered off and all capacitors should be completely discharged prior to testing. A more accurate measurement can be achieved by separating the component from the circuit being tested.

5-2. AC/DC Voltage

DC VOLTAGE \bar{V}

1. **Insert test leads** - Insert the black test lead into the **COM** input and the red test lead into the $\frac{V}{\Omega}$ input.

2. **Set \bar{V} function** - Turn the dial to the \bar{V} function.

3. **Test & Measure** - Place the red and black test leads at the positive and negative points to be measured, the clamp meter will automatically select the proper range, and the display will show the DC voltage value being measured. If the potential at the red test leads is higher than the potential at the black test leads, the display will either show a positive voltage value or a negative voltage value.

\triangle WARNING

DC voltage measurement should not exceed 600V DC!

AC VOLTAGE \tilde{V}

1. **Insert test leads** - Insert the black test lead into the **COM** input and the red test lead into the $\frac{V}{\Omega}$ input.

2. **Set \tilde{V} function** - Turn the dial to the \tilde{V} function.

3. **Test & Measure** - Place the red and black test leads at both the positive and negative points to be measured. The clamp meter will automatically select the proper range and the display will show the value of the measurement being taken.

\triangle WARNING

AC voltage measurement should not exceed 600V AC!

5-3. AC Current \tilde{A}

1. **Set 400 \tilde{A} or 200 \tilde{A} function** - Turn the dial to the 400 \tilde{A} or 200 \tilde{A} function.

2. **Test & Measure** - Using the trigger, open the clamp meters jaw and clamp around the conductor. Make sure that the conductor is positioned in the center and that the flow of current matches the arrows located on the jaws of the clamp meter. The clamp meter will automatically select the proper range and the display will show the value of the measurement being taken. Note: Ensure that the test leads are disconnected from the meter before making measurements. Only clamp around a single conductor at a time.

\triangle WARNING

The maximum measured current should not exceed 400 \tilde{A} AC when measuring AC current.

6. OTHER FEATURES

6.1. Auto shut off / Auto shut of disable

1. The meter has an auto shut off feature to preserve battery life.
2. The meter will shut off after 15 minutes of non-use.
3. Data hold information will not be retained if the auto off feature is enacted.
4. If the meter is turned off by this feature the operator should rotate the dial back to the **OFF** position to resume normal operation.
5. The auto shut off feature can be disabled by holding down the **SELECT** button while rotating the dial from the OFF position. This function will be disabled until the meter is turned off.

6.2. Low battery indicator

1. The meter has a low battery indicator that will alert the user when the voltage is too low to provide accurate readings.
2. The  indicator will display when the batteries have less than 3.6V of power.
3. Replace the batteries when this indicator is displayed (See Section 7, Battery Replacement).

6.3. Data hold

1. The meter has a data hold feature that will retain the measured value on the LCD screen.
2. Press the **HOLD** button momentarily to retain the measured value.
3. The  symbol will be displayed while the value is being retained.
4. Press the **HOLD** button again to resume normal operation.

6.4. Select button

1. The function **SELECT** button is used to switch between functions at the $\bullet \cdot \cdot$ / \rightarrow / Ω measurement settings.

6.5. MAXH

1. The Max Hold (**MAXH**) function retains the highest measurement value being recorded.

6.6. Buzzer

1. The **BUZZER** will sound when you press any of the function keys and it will also sound when the dial is turned. The **BUZZER** will also sound when taking measurements for **Diode**, **Continuity** and **NCV**. The **BUZZER** will beep three times in continuation 1 minute prior to auto shutdown; prior to shutdown the **BUZZER** will alarm with a long beep.

6.7. Polarity indication

1. The meter displays “-” for negative values, positive is implied

6.8. Over Range indication

1. When the input exceeds the measuring range “OL” is displayed on the LCD screen

6-9. Non-contact Voltage (NCV) Detection

WARNING

- Test on a known live source before use
- Even if the meter does not provide indication, potentially hazardous voltage could still be present (The meter will only detect voltages above 50VAC and only when conditions are correct)
- The meter can be affected by: Distance from voltage source, Condition of meter and batteries, Shielded wires, Metal enclosures, Insulation thickness, and Static charge among other things

1. Remove the test leads
2. Rotate the dial to the “NCV” position
3. The meter will display “O.L.” when the NCV function is being used
4. Position the tip of the clamp meter jaws near the voltage source
5. A continually cycling tone will be emitted when the meter senses AC voltage greater than ~50V

(The meter is sensitive to electrostatic fields. Occasionally a static charge may interfere with the meter detection and the meter may omit a tone momentarily.)

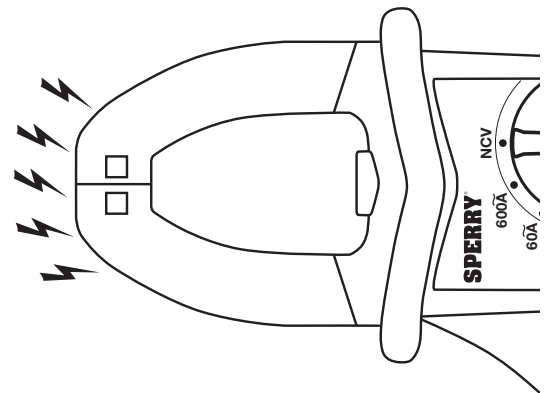

7. BATTERY REPLACEMENT

⚠ WARNING

- To avoid electrical hazard, set the Function Switch to “OFF” and remove the test leads from the instrument before trying to replace batteries.

⚠ CAUTION

- Do not mix old and new batteries.
- Install batteries in correct polarity as indicated in the Battery Compartment.

1. Rotate the dial to the “OFF” position and remove the test leads
2. Rotate the 1/4 turn fastener CCW with a screwdriver or coin and remove the cover
3. Replace the batteries observing correct polarity
4. Use new R03 (AAA) or LR03 / 1.5V batteries.
5. Reinstall the door and rotate the 1/4 turn fastener CW to secure the cover.

Replace the batteries when a low battery symbol is displayed on the LCD screen.

When the battery is completely exhausted, the display will appear blank and no symbol will be shown.

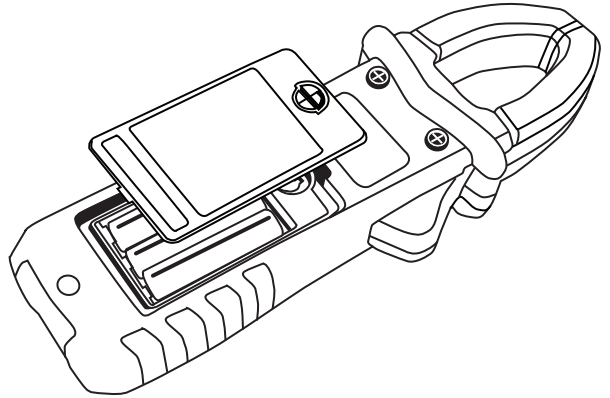

8. MAINTENANCE

Cleaning: Use only a soft cloth dampened with water or neutral detergent for cleaning the meter. Do not use abrasives, solvents or harsh chemicals. Allow to dry thoroughly before use.

SPERRY INSTRUMENTS LIMITED LIFETIME WARRANTY

Subject to the exclusions and limitations detailed below, Sperry Instruments provides a limited lifetime warranty on products of its manufacture will be free from defects in materials and workmanship under normal use and service.

Limited

Limited means that Sperry Instruments warrants to the original purchasers of products from Sperry Instruments authorized distributors at the time of shipment such products shall be free of defects in material and workmanship while the tool is used under normal working conditions. Standard wear and tear, dulling over time, overloading, misuse, and acts of God are not covered under warranty. This warranty does not cover batteries, fuses, or test leads.

When a warranty claim arises, the purchaser must contact Sperry Instruments. If the defect comes under the terms of this limited warranty, Sperry Instruments will arrange, at its sole discretion, one of the following options:

- Product will be replaced

The purchaser is solely responsible for determining the suitability of Sperry products for the purchaser’s use or resale, or for incorporating them into articles or using them in the purchaser’s applications. The distributor is authorized to extend the foregoing limited warranty to its original purchasers in connection with the sales of Sperry products, provided that such products shall not have been altered by the distributor. The distributor shall be fully responsible for any warranties the distributor makes to its purchasers which are broader or more extensive than Sperry’s limited warranty.

Lifetime Warranty

Warranty Limitation: The foregoing warranties are exclusive and are in lieu of all other express and implied warranties whatsoever, including but not limited to implied warranties of merchantability and fitness for a particular purpose. The foregoing warranties do not cover ordinary wear and tear, abuse, misuse, overloading, alterations, products which have not been installed, operated or maintained in accordance with Sperry’s written instructions. Test leads, fuses, batteries and calibration are not covered under any implied warranty. “Lifetime” of products that are no longer offered by Sperry will be either repaired or replaced with an item of Sperry Instruments choice of similar value. Lifetime is defined as 5 years after Sperry discontinued manufacturing the product, but the warranty period shall be at least ten years from date of purchase. Original proof of purchase is required to establish original ownership of product.

No warranty will be honored unless an invoice or other proof of purchase date is provided to Sperry Instruments. Hand written receipts or invoices will not be honored.

©2016 Power Products, LLC All rights reserved.

- See more at: <https://www.sperryinstruments.com/en/Resources/Warranty-Information>

**SPERRY
INSTRUMENTS**

Sperry Instruments
800-645-5398
Menomonee Falls, WI 53051
sperryinstruments.com